

# HOW TO MAKE TRIANGULAR PIECES

## ●Using origami paper: Type "A"

The rectangular piece for Type "A" has an exact ratio of 2 : 1 for length to width because it is a half of square origami paper. Some projects require other types which have a slightly different ratio. (See P.28-29.)

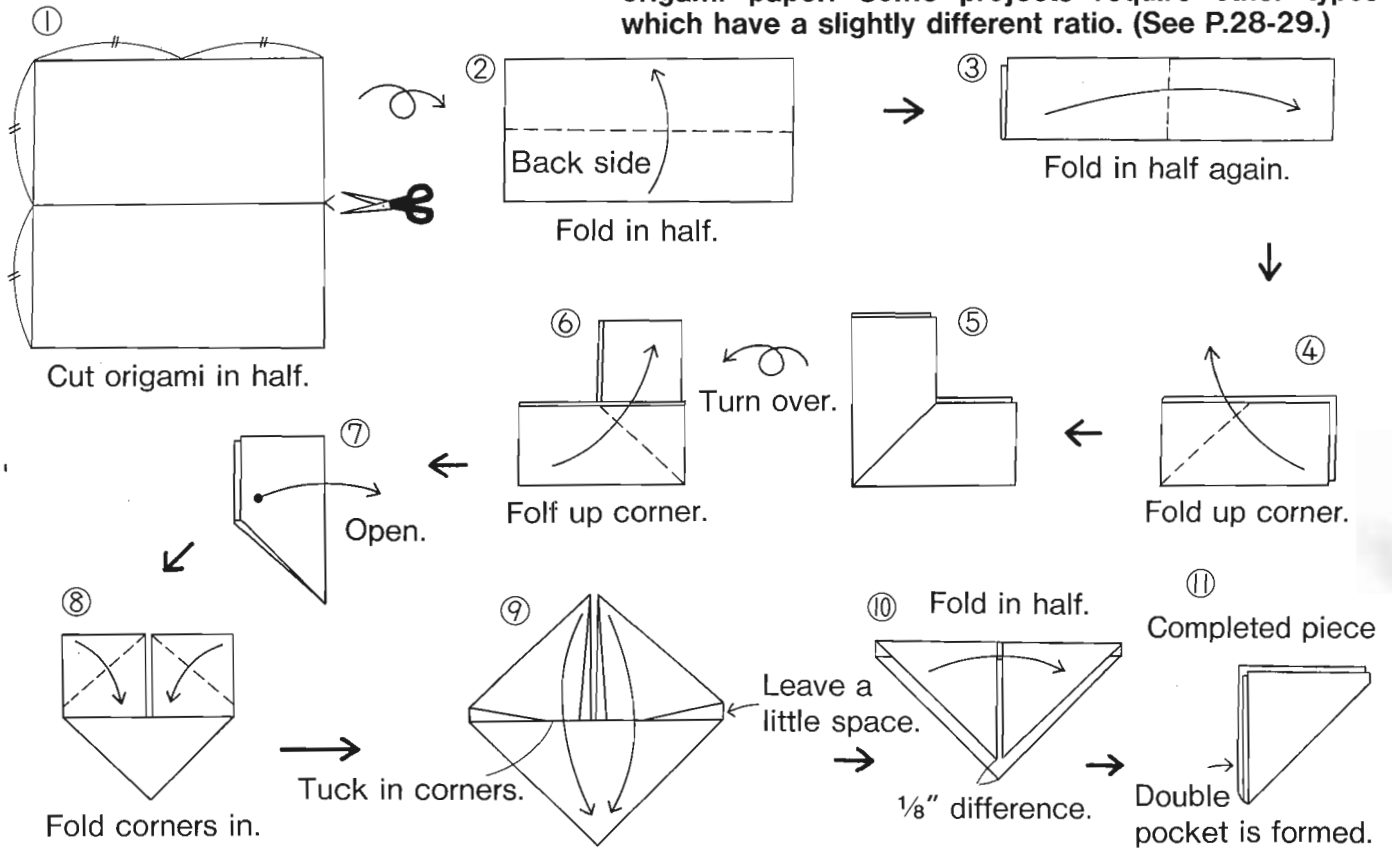

## ★Basic Assembly

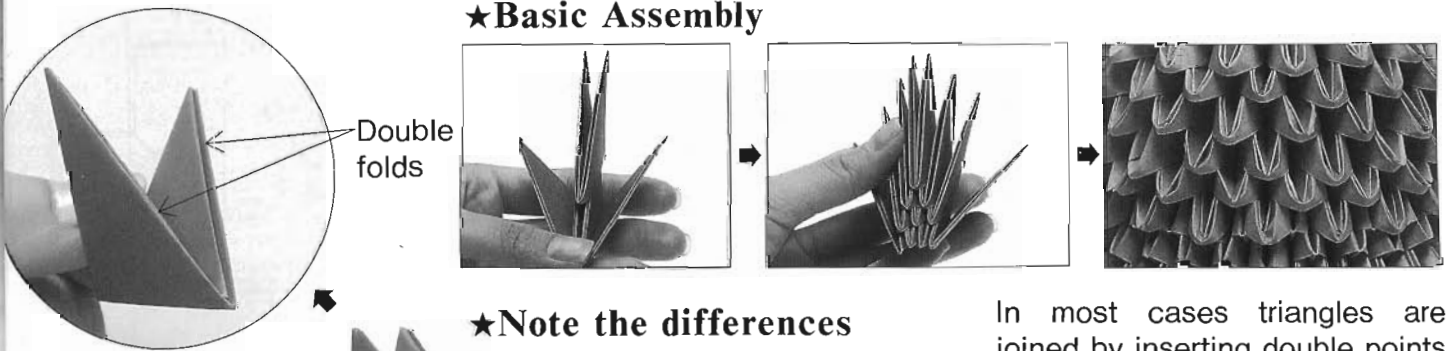

## ★Note the differences between the three sides.

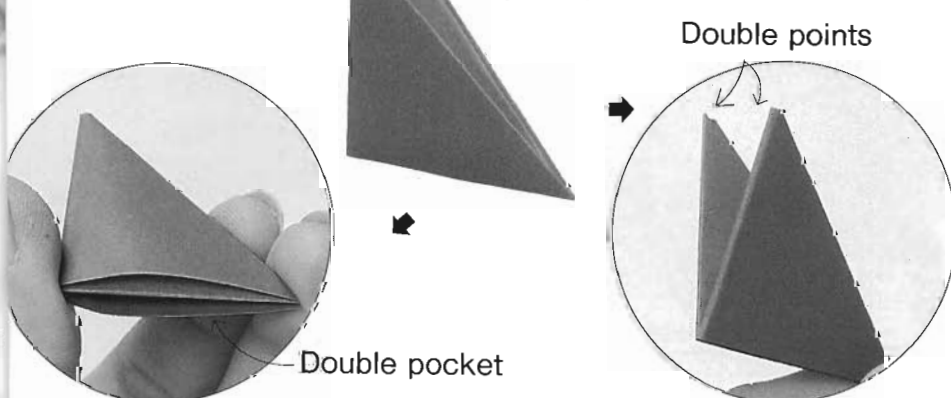

In most cases triangles are joined by inserting double points of a triangle into the double pockets of new triangles.

Hold two pieces together, double points facing up, then stack on a new piece by inserting two middle points into the double pockets. This makes the second row that connects the pieces of the first row at the same time.

# HOW TO MAKE TRIANGULAR PIECES

●Using flyer or wrapping paper: Type "B" Usually commercial paper does not have the exact ratio of 2 to 1 for its length to width. So the width of Type "B" rectangle is slightly longer than a half of the length. This type piece is often useful.

## [Cut into rectangles]

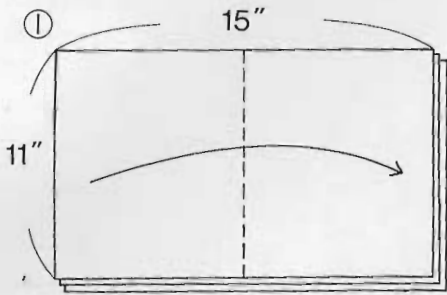

Layer several sheets aligning edges. Fold and cut into halves.

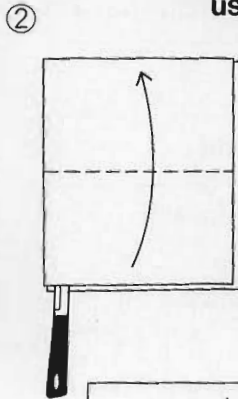

Fold and cut into halves again.

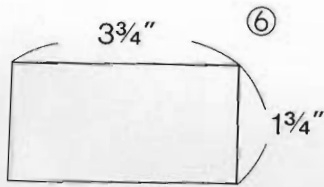
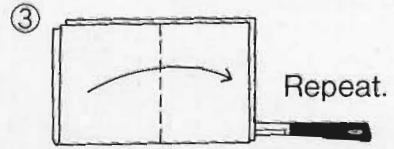

Basic rectangle

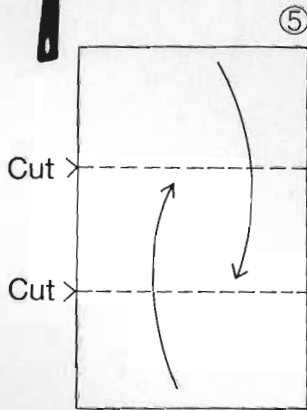

Precisely fold each into 1/3 rectangle, and cut.

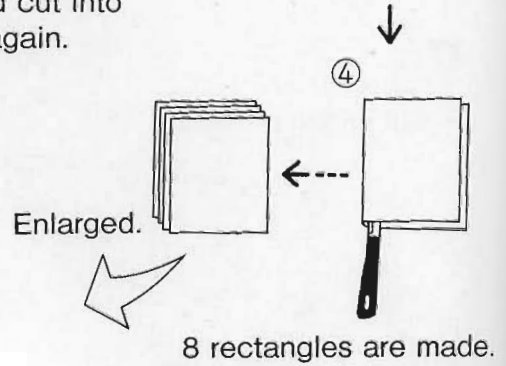

## [Fold into triangles]

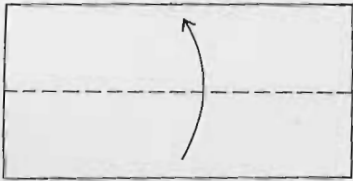

Fold in half.



Fold in half again.

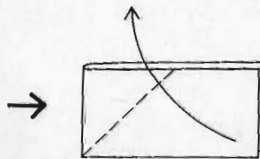

Fold up corner.

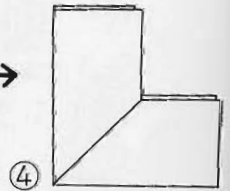

Turn over.

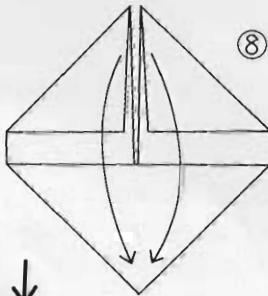

Fold down.

Fold corners in.

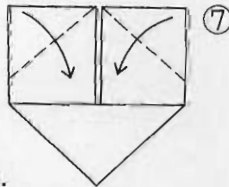

Leave a little space.

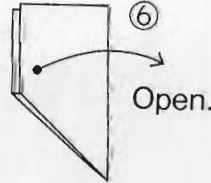

Open.

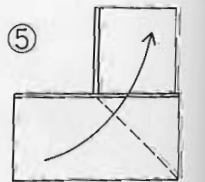

Fold up corner.

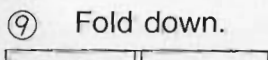

Double pocket is formed.

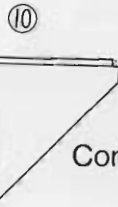

Completed peice

1/8" difference

# HOW TO MAKE TRIANGULAR PIECES

●Using craft paper: Type "C"

Commercial rectangular papers are available at handicraft shops. This Type "C" rectangle has a width slightly less than a half of the length.

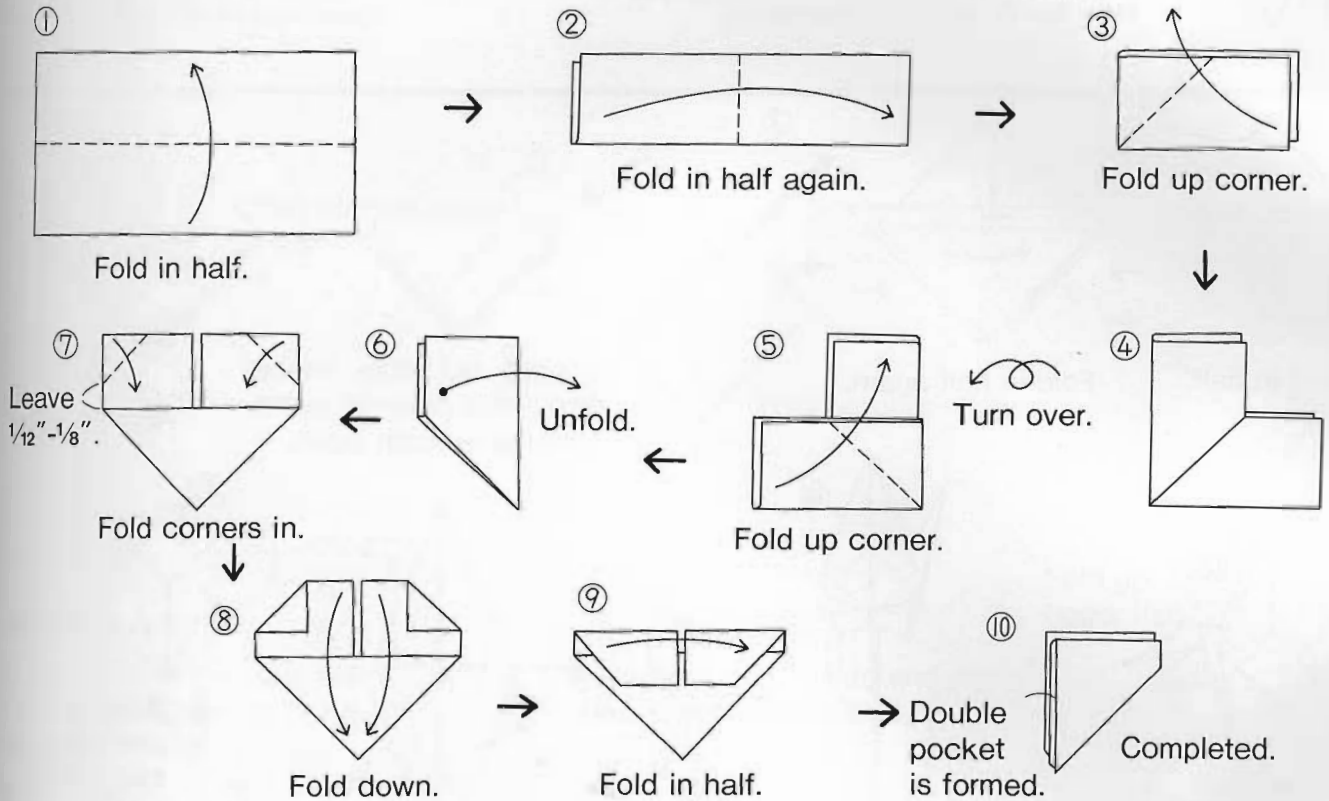

## UTENSILS

- ① Cutting board
- ② Flyer
- ③ Ruler
- ④ Scissors
- ⑤ Paper cutter
- ⑥ Bamboo skewer to apply glue
- ⑦ Wood glue
- ⑧ ⑨ ⑩ Craft papers

